

**BRASSELER**  
USA® BY YOUR SIDE

**HANDPIECES &  
SMALL EQUIPMENT**

# NL9000™

*Its Performance is Legendary...*

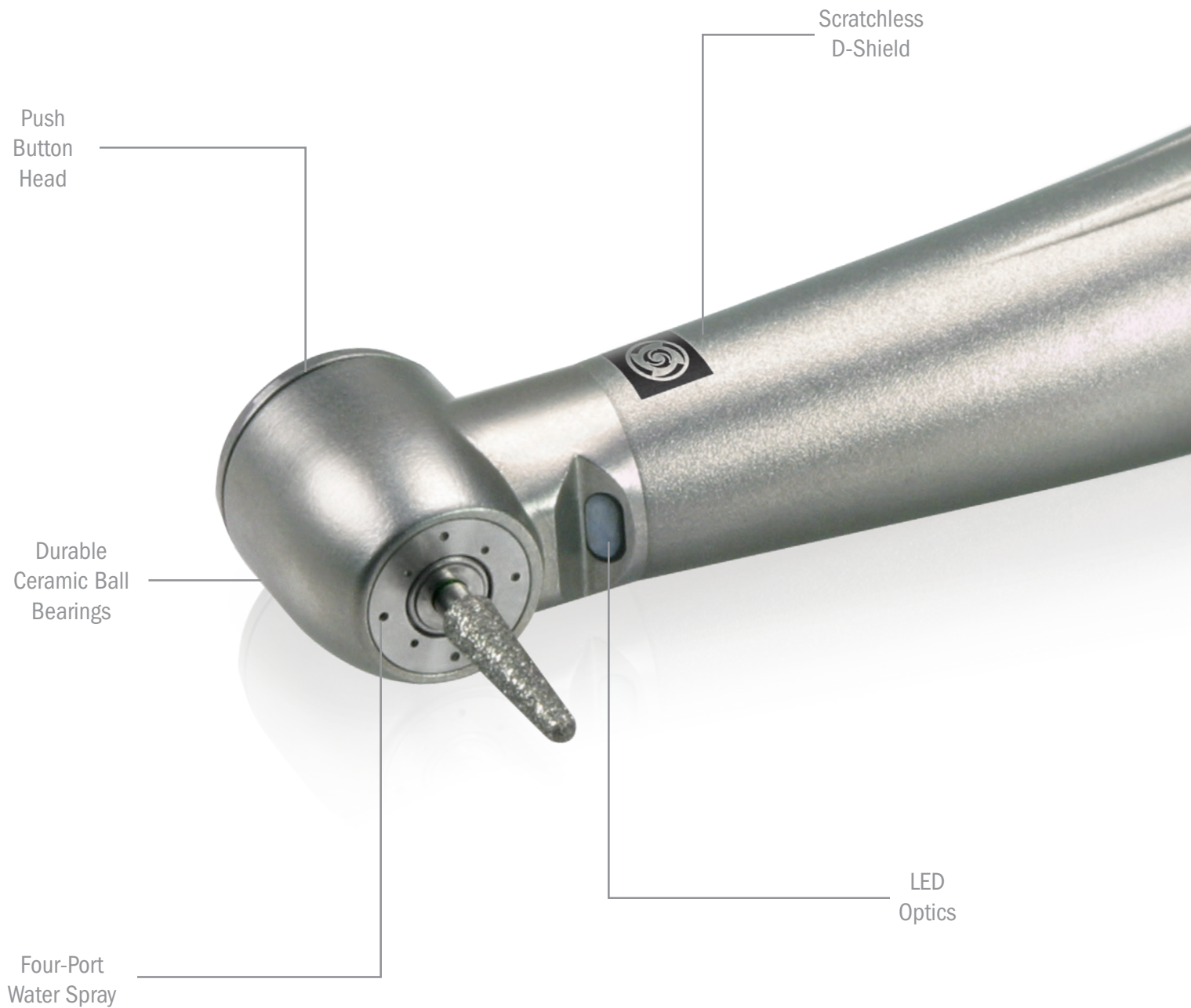



Lightweight  
Titanium

360°  
Swivel

The Brasseler USA NL9000 was engineered with one thought in mind: Performance.

Constructed of lightweight, high-strength titanium, the NL9000 sets the standard for high speed air handpieces. Featuring ceramic bearings, quick disconnect swivel coupling and fiber optics, the NL9000 is available in miniature, standard and high-torque head sizes.



# NL9000™



## NL9000M - Miniature Head Size

**Order Number: 5021261U0**

For Brasseler Coupler  
Torque: 17 Watts  
Max Speed: 450,000 rpm

## NL9000S - Standard Head Size

**Order Number: 5021262U0**

For Brasseler Coupler  
Torque: 21 Watts  
Max Speed: 440,000 rpm

## NL9000T - Torque Head Size

**Order Number: 5021263U0**

For Brasseler Coupler  
Torque: 22 Watts  
Max Speed: 360,000 rpm

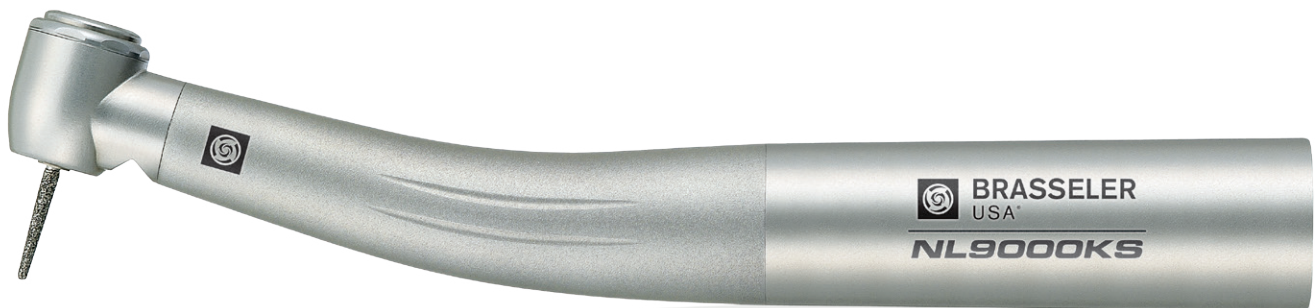

## NL9000KM - Miniature Head Size

**Order Number: 5021264U0**

For KaVo® MULTiflex® Coupler  
Torque: 16 Watts  
Max Speed: 450,000 rpm

## NL9000KS - Standard Head Size

**Order Number: 5021265U0**

For KaVo® MULTiflex® Coupler  
Torque: 18 Watts  
Max Speed: 440,000 rpm

## NL9000KT - Torque Head Size

**Order Number: 5021266U0**

For KaVo® MULTiflex® Coupler  
Torque: 19 Watts  
Max Speed: 360,000 rpm

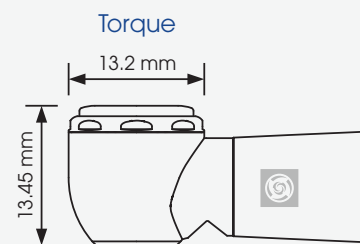
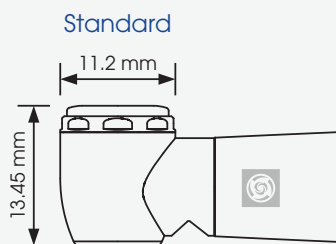
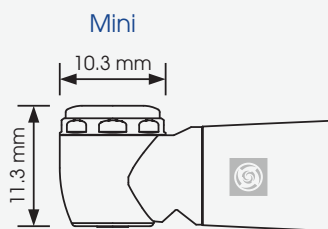



# LED Couplers *Excellence Illuminated...*

**CLEARER:** LEDs generate natural daylight-quality light, which assures clearer vision when compared to halogen light.

**DURABLE:** LED light sources are longer-lasting and more durable than halogen bulbs, saving you money.

**SAFER:** LED light is safer because it generates less heat than a halogen bulb.

## NL10LED

**Order Number: 5021283U0**

For Brasseler Handpiece Connections  
LED Fiber Optics  
6-Pin Tubing Connection



## NKLED

**Order Number: 5021284U0**

For KaVo® MULTiflex® Connections  
LED Fiber Optics with Water Adjustments  
6-Pin Tubing Connection



## NL10Ti

**Order Number: 5021281U0**

For Brasseler Handpiece Connections  
Fiber Optics  
6-Pin Tubing Connection



## NL11Ti

**Order Number: 5021282U0**

For Brasseler Handpiece Connections  
Fiber Optics  
5-Hole Tubing Connection



## N10Ti

**Order Number: 5021278U0**

For Brasseler Handpiece Connections  
Non-Optic  
4-Hole Tubing Connection



# BRIO440™

*Performance and Value...*

The Brio440 handpiece from Brasseler USA offers a powerful yet economic alternative in high speed handpieces. Featuring ceramic ball bearings, optic and non-optic options, 4-port water spray and swivel quick disconnect, the Brio440 provides a unique mix of performance and value in a high speed handpiece.

Powerful  
20 Watts  
of Torque

Durable  
Ceramic Ball  
Bearings

Four-Port  
Water Spray

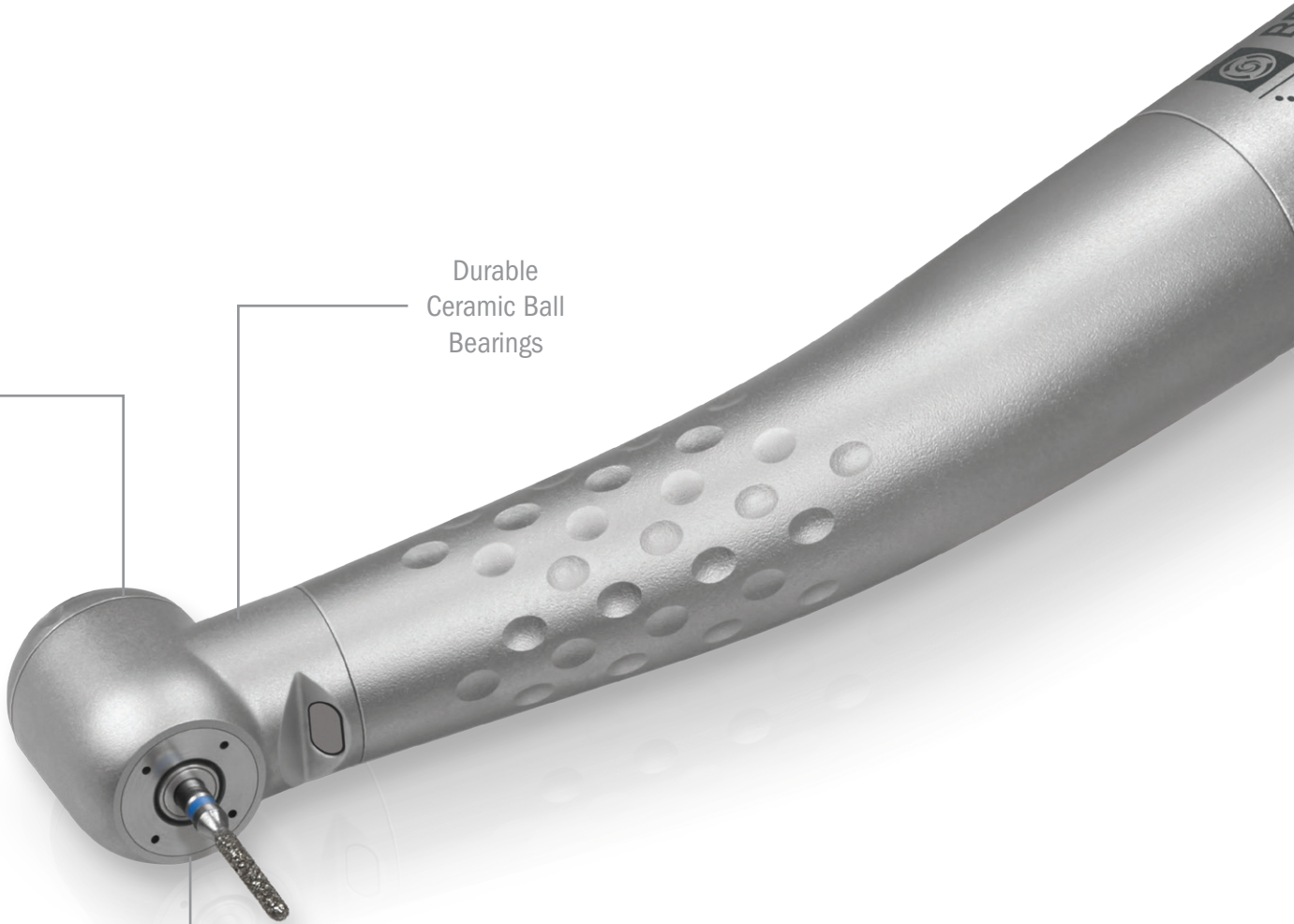

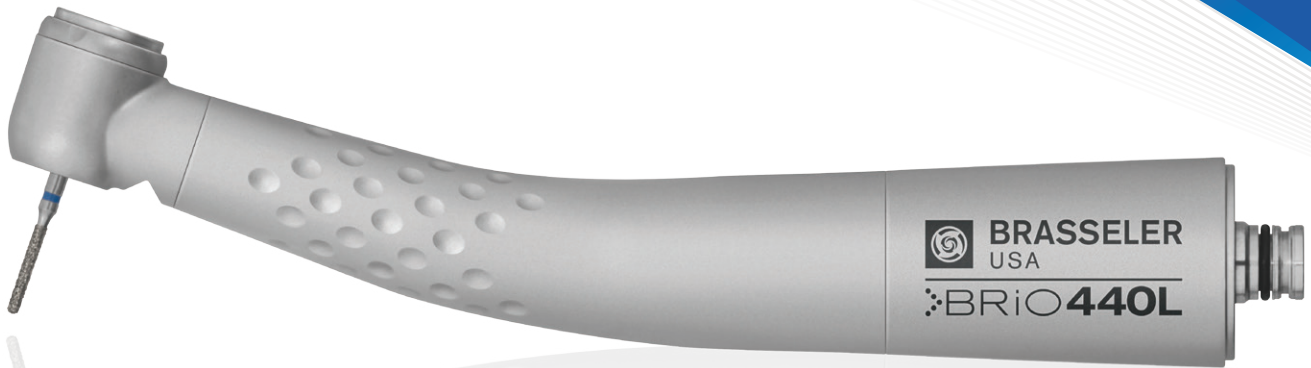

**Brio440L Optic**  
**Order Number: 5026058U0**

Torque: 20 Watts  
Weight: 50g  
Head Height: 12.3mm  
Head Diameter: 10.5mm  
Max. Speed: 395,000 RPM  
Body: Stainless Steel



**Brio440 Non-Optic**  
**Order Number: 5026059U0**

Torque: 20 Watts  
Weight: 47g  
Head Height: 12.3mm  
Head Diameter: 10.5mm  
Max. Speed: 395,000 RPM  
Body: Stainless Steel

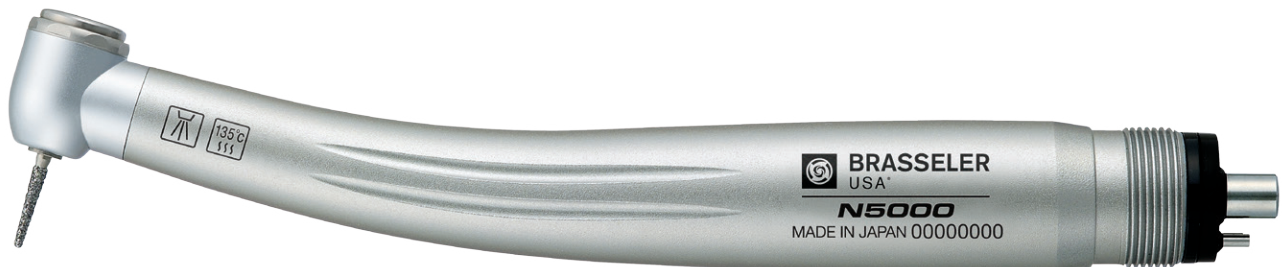

**N5000 - Standard Head Size**  
**Order Number: 5021274U0**

4 Hole Tubing Connection  
Non-Fiber Optic  
Torque: 16.5 Watts  
Max Speed: 450,000 rpm  
1 Year Warranty



# NL4500™

*The Standard in Safe Access...*

The NL4500 handpiece from Brasseler has a unique 45° angle head design that allows for maximum visibility and posterior access and is ideal for treating impacted molars. Equally important is the special triple-port design that delivers a water stream - not a mist - directly to the tip of the bur. The NL4500 delivers powerful torque and features ceramic ball bearings and a push button head, all in a lightweight design.

Durable  
Ceramic Ball  
Bearings

Unique  
45° Head

Triple Port  
Water Spray

Lightweight  
Titanium

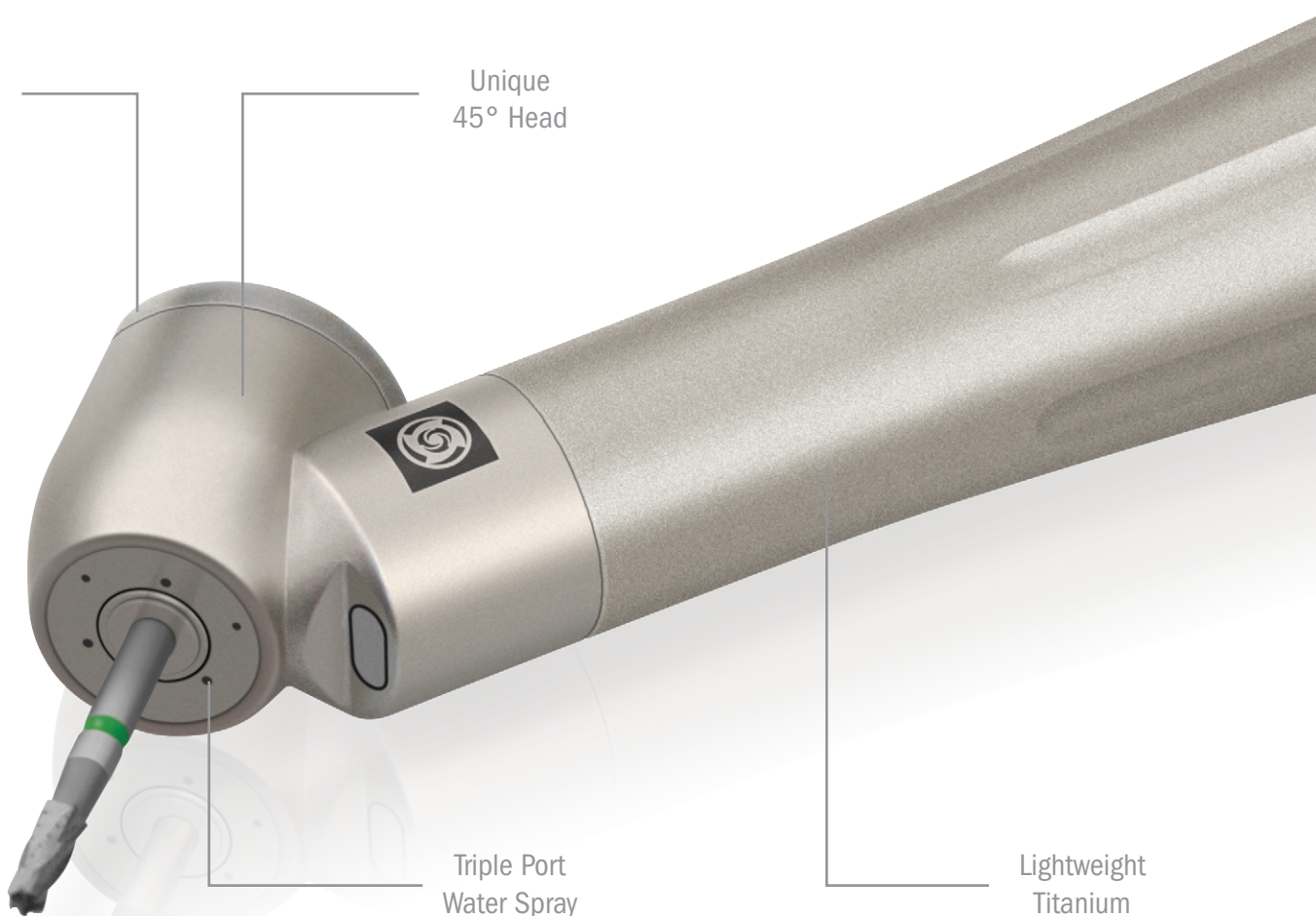



**NL4500 - Standard Head Size**  
**Order Number: 5025051U0**

For Brasseler Coupler Connections  
Fiber Optic  
Torque: 21 Watts  
Max Speed: 450,000 rpm  
2 Year Warranty

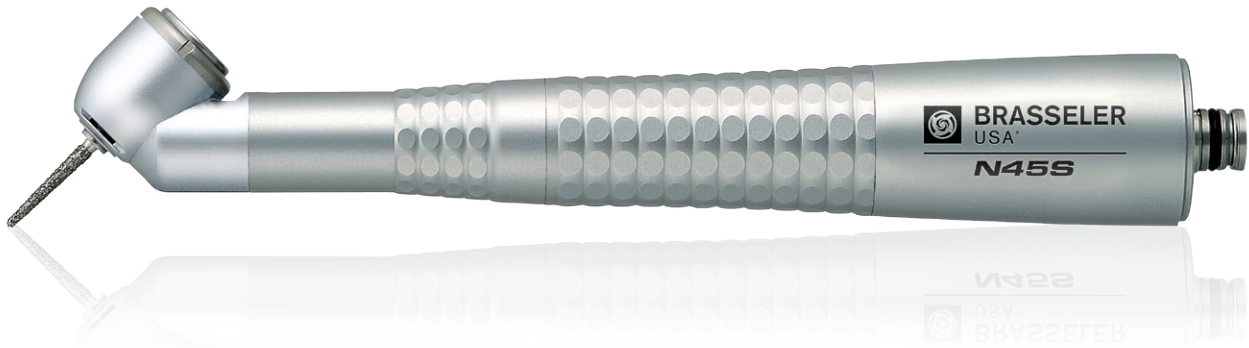

**N45S - Standard Head Size**  
**Order Number: 5021272U0**

For Brasseler Coupler Connections  
Non-Fiber Optic  
Torque: 15 Watts  
Max Speed: 450,000 rpm  
1 Year Warranty

# BRASSELER® MINI™

*When “Open Wide” isn’t Enough...*

Small in size but big in performance, the Brasseler MINI high speed handpiece offers a super miniature head size that provides maximum access and visibility. The lightweight handpiece features ceramic ball bearings, quick disconnect swivel and an easy-to-replace turbine. A revolution in handpiece design, the Brasseler MINI is a necessity for your limited access cases.

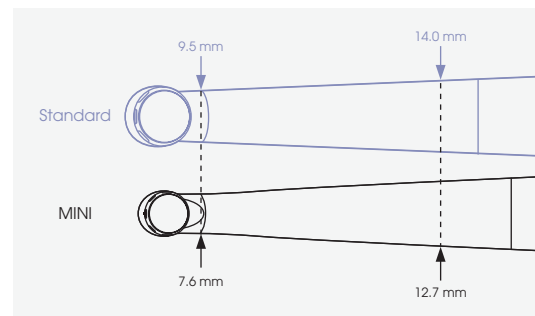
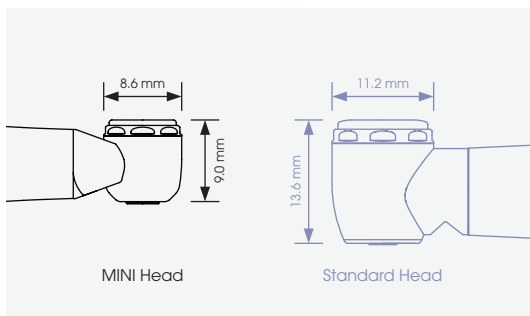
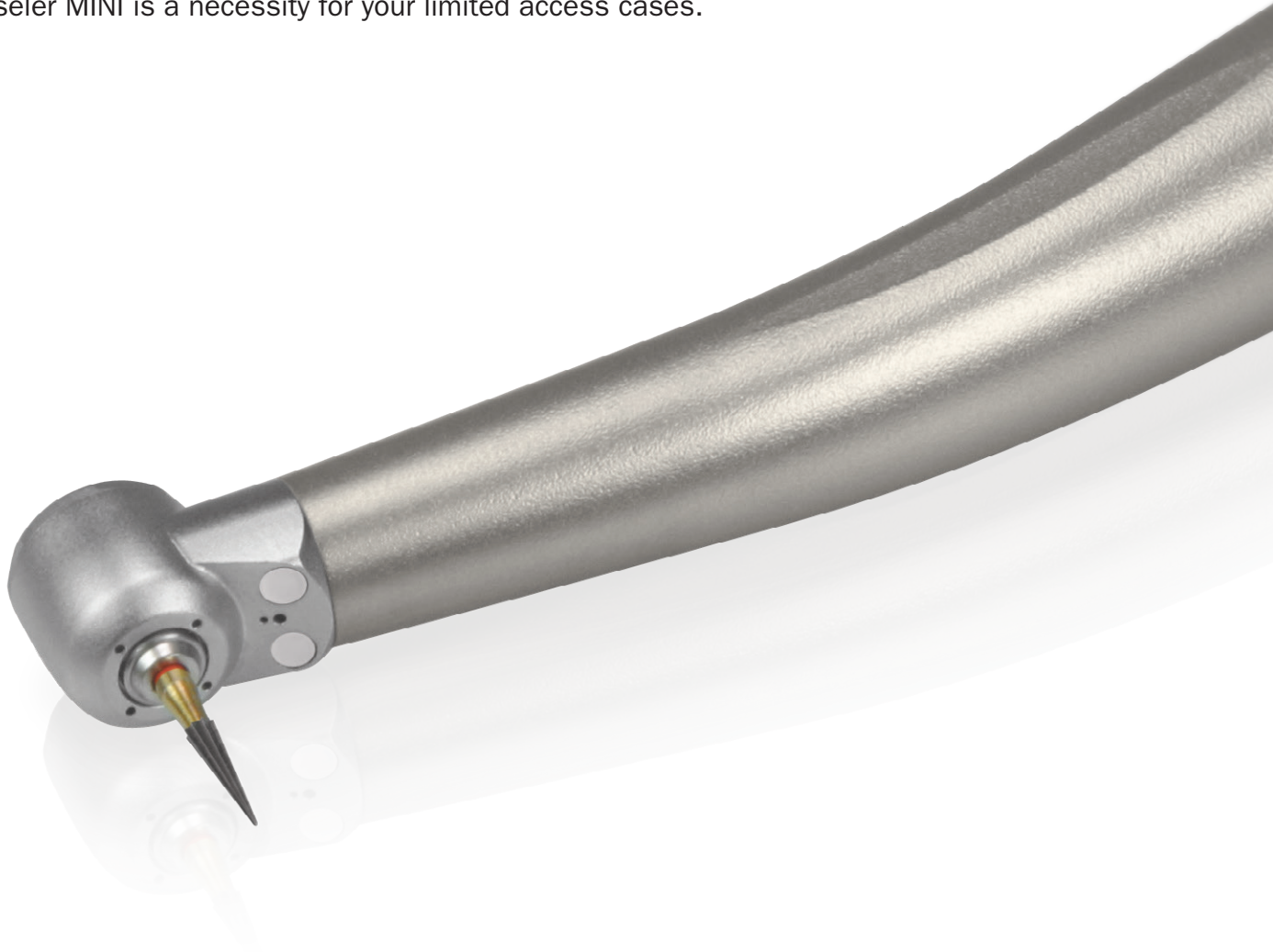





**Brasseler MINI**

**Order Number: 5021970U0**

For Brasseler Coupler Connections

Fiber Optic

Recommended with Brasseler MINI Burs

1 Year Warranty



**Brasseler MINI KV**

**Order Number: 5022751U0**

For KaVo® MULTiflex® Coupler Connections

Fiber Optic

Recommended with Brasseler MINI Burs

1 Year Warranty

*Recommended with Brasseler MINI burs:*



31 - FG Standard



33 - FG Short Shank



32 - FG MINI

# FORZA™

## Clinical Electric Systems



E-Type  
Motor

Lightweight  
Titanium

FORZA ELM

Fully  
Autoclavable  
at 135°C

LED  
Optics

# FORZA™ ELM

*Changing the Way You Think About Electric Handpieces...*

The Forza ELM is arguably the most advanced clinical micromotor. The Forza ELM is a celebration of details, from the lightweight titanium motor to the LED fiber optics. With the lightest motor in its class and a powerful 3.4 Ncm of torque, this micromotor can be integrated into any dental delivery system. The Forza ELM will change the way you think about electric handpieces.

## **Forza ELM Electric Micromotor**

**Order Number: 5021312U0**

System Includes Motor, Cord, Control Unit and AC Adapter

Two Programmable Settings

Motor Speed Range: 2,000-40,000 rpm

Attachments Provide a System Speed Range of 100-200,000 rpm

Torque: 3.4 Ncm

Motor Weight: 59 Grams

LED Optics

3 Year Warranty





# FORZA™

## Clinical Electric Systems



E-Type  
Motor

Lightweight  
Titanium

FORZA ELS

Fully  
Autoclavable  
at 135°C

# FORZA™ ELS

*Muscular yet Mindful...*

The Forza ELS sets the standard for clinical micromotors with a powerful 3.0 Ncm of torque in a compact, lightweight design. Smooth, quiet, and versatile, the Forza ELS features two programmable settings and an easy-to-read digital speed display. Whether cutting through obsolete crowns or refining margins, the Forza ELS delivers the power and control demanded by dentists today.

## Forza ELS Electric Micromotor

**Order Number:5021306U0**

System Includes Motor, Cord, Control Unit and AC Adapter

Two Programmable Settings

Motor Speed Range: 2,000-40,000 rpm

Attachments Provide a System Speed Range of 100-200,000 rpm

Torque: 3.0 Ncm

Motor Weight: 76 Grams

3 Year Warranty



# FORZA™ Attachments

*Masterpieces of Aesthetic and Structural Engineering...*

Constructed of lightweight, high-strength titanium, the Forza attachments are masterpieces of aesthetic and structural engineering. The state-of-the-art gear design incorporated in the Forza attachments delivers smoother performance and increased durability. The E-Type Forza attachments are compatible with most electric motors on the market and come in a wide range of gear ratios that offer the perfect solution for your practice.

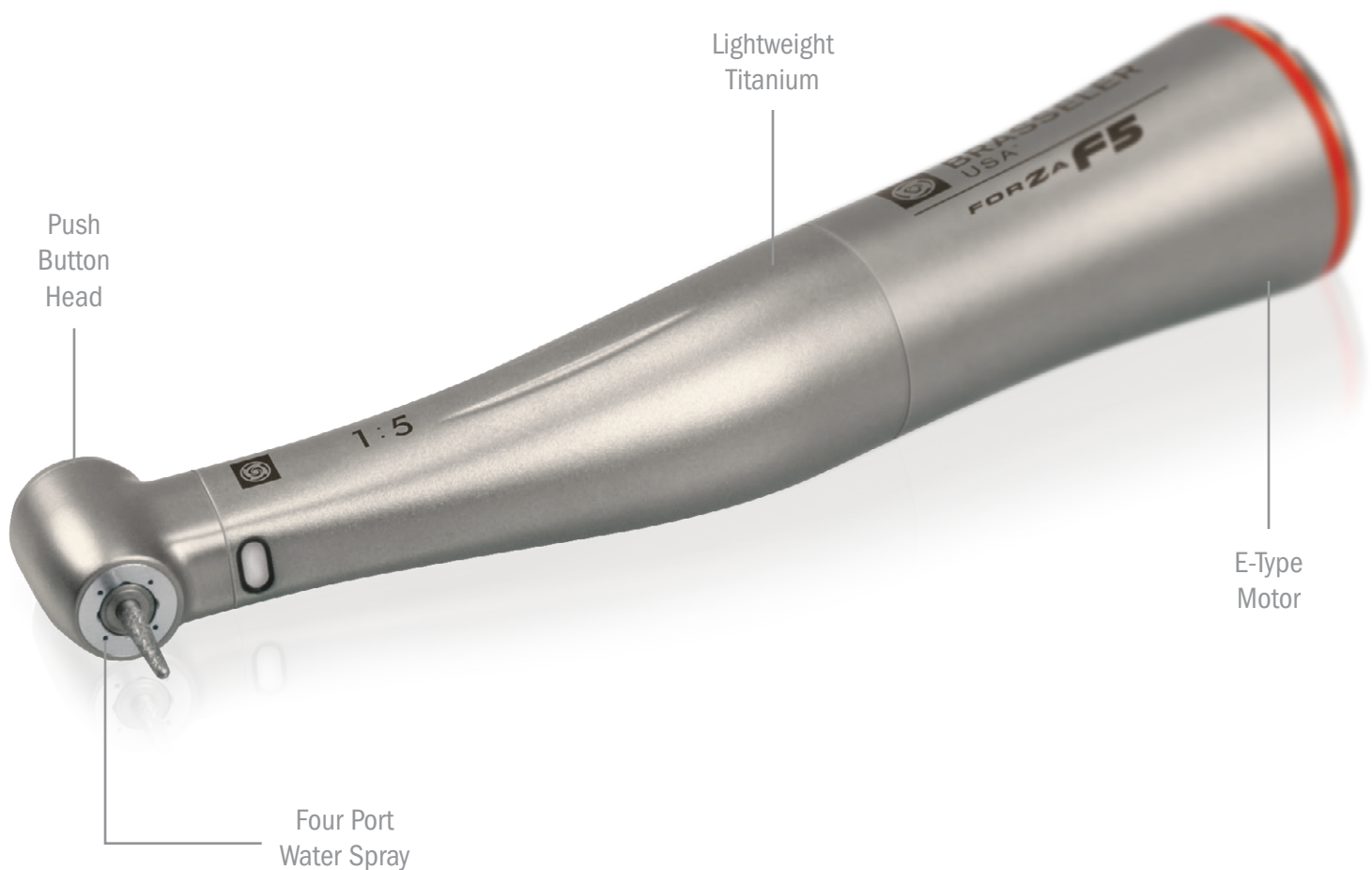





### Forza F5

**Order Number: 5021285U0**

- 1:5 Speed Increasing
- Optic
- Speed Range: 10,000-200,000 rpm
- For Friction Grip Burs
- Four-Port Spray
- 2 Year Warranty



### Forza F1

**Order Number: 5021288U0**

- 1:1 Gear Ratio
- Optic
- Speed Range: 2,000-40,000 rpm
- For Latch Type Burs
- Single-Port Spray
- 2 Year Warranty



### Forza F1S

**Order Number: 5021292U0**

- 1:1 Gear Ratio
- Non-Optic
- Speed Range: 2,000-40,000 rpm
- For Straight Handpiece Burs
- Single-Port Spray
- 2 Year Warranty

# LS SERIES

## Low Speed Air

*Durability Redefined...*

The LS Series from Brasseler USA delivers muscular performance and proven reliability for all your low speed clinical applications. You will find a unique mix of durability, strength and versatility reflected throughout this lightweight motor. The LS Series offers a variety of head and gear reduction angles, providing you with the perfect fit for your low speed procedural needs.

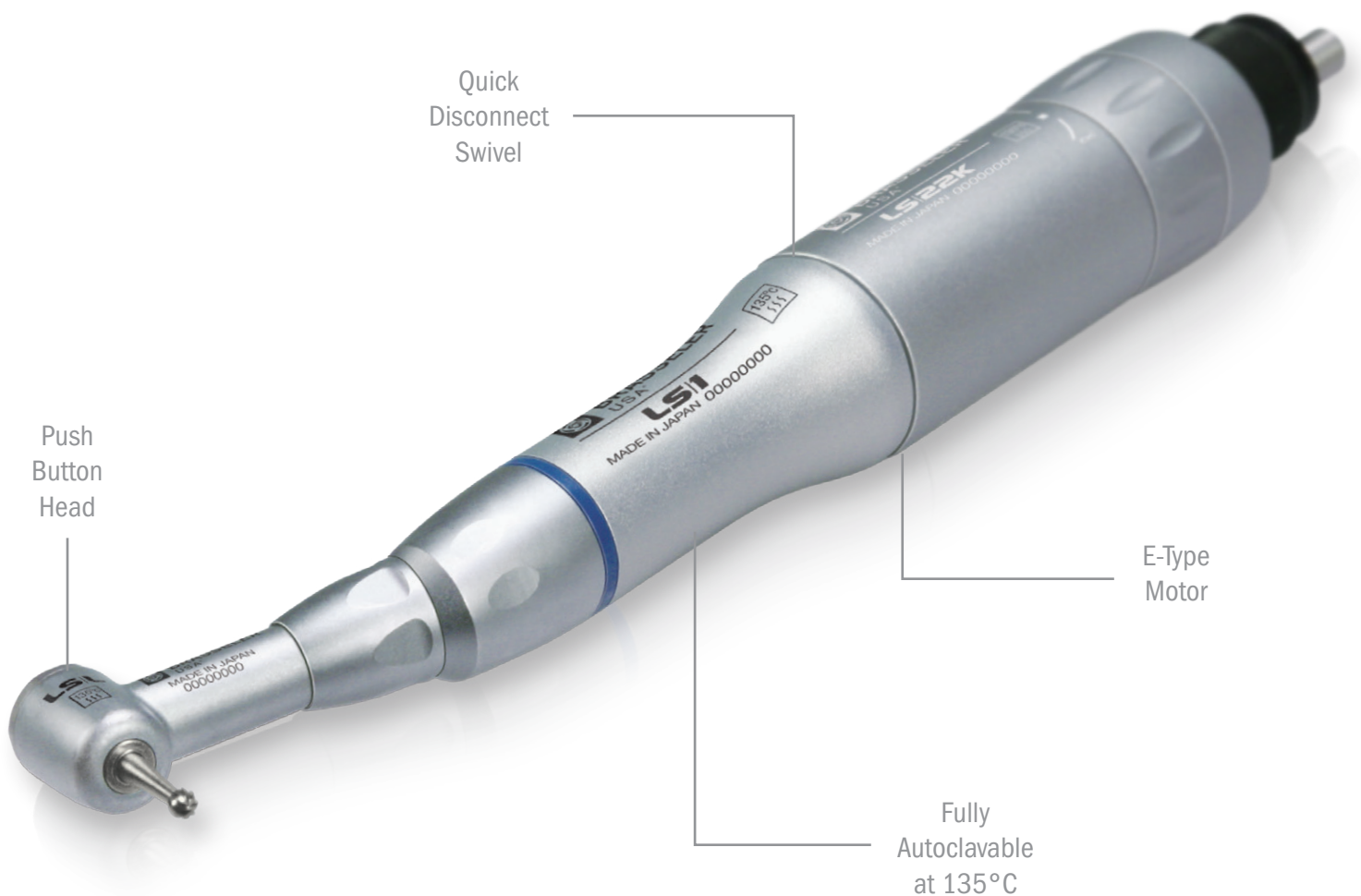



### LS22K Air Motor

**Order Number: 5021316U0**

Motor Speed Range: 0-22,000 rpm  
Connects Directly to 4 Hole Tubing  
1 Year Warranty



### LS1L Attachment

**Order Number: 5021300U0**

1:1 Drive for Latch Type Burs  
1 Year Warranty



### LS1F Attachment

**Order Number: 5021301U0**

1:1 Drive for Friction Grip Burs  
1 Year Warranty



### LS1S Straight Nosecone

**Order Number: 5021294U0**

1:1 Drive  
For Straight Handpiece Burs and Disposable Prophy Angles  
1 Year Warranty



### LSL Head

**Order Number: 5021302U0**

For Latch Type Burs  
Push Button Head  
1 Year Warranty



### LSF Head

**Order Number: 5021305U0**

For Friction Grip Burs  
Push Button Head  
1 Year Warranty



### LS1 Sheath

**Order Number: 5021296U0**

1:1 Drive  
1 Year Warranty



### LS4 Sheath

**Order Number: 5021298U0**

4:1 Drive  
1 Year Warranty



# ENDOSYNC™

*Smart. Safe. Simple.*

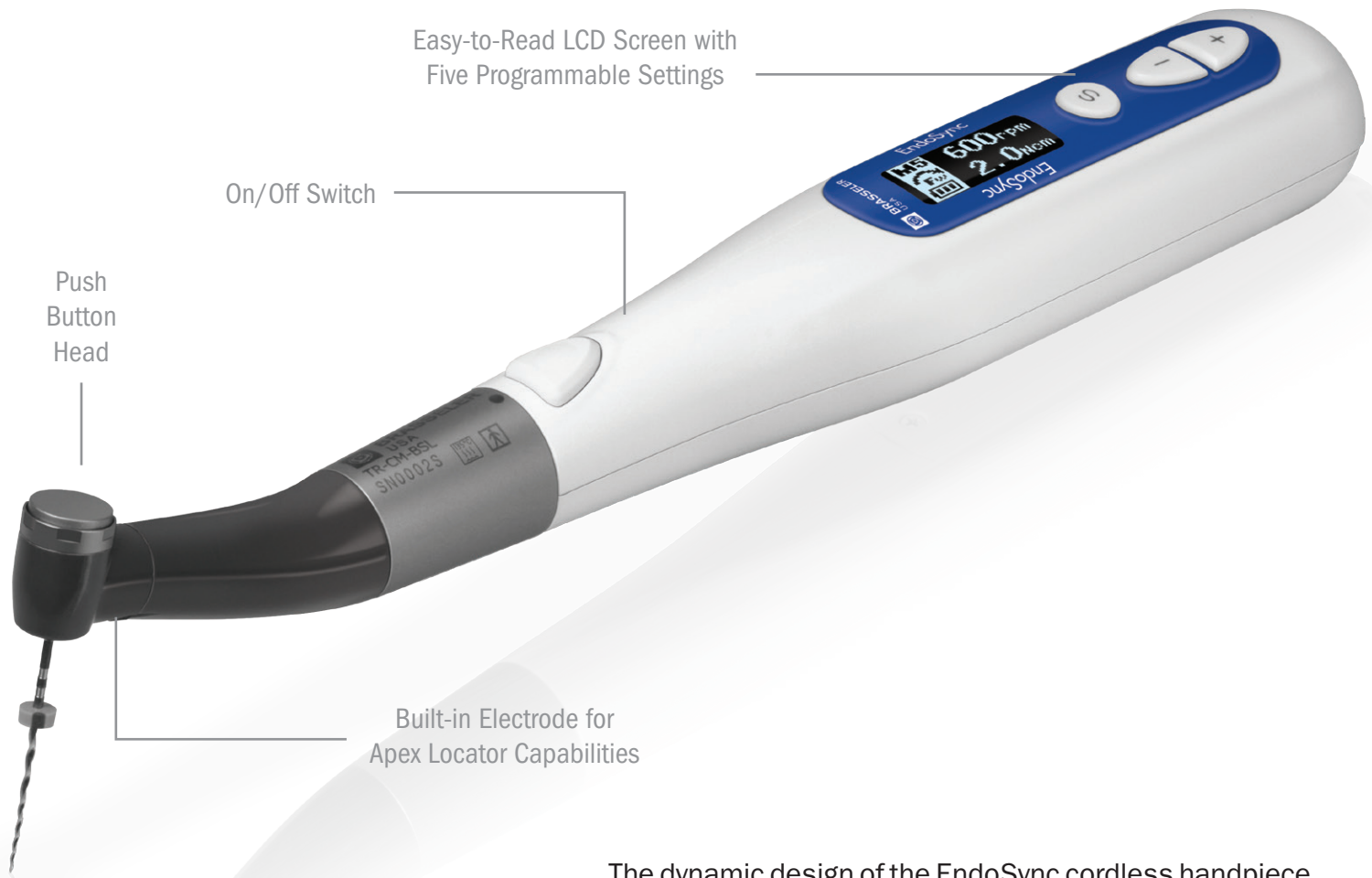

Easy-to-Read LCD Screen with  
Five Programmable Settings

On/Off Switch

Push  
Button  
Head

Built-in Electrode for  
Apex Locator Capabilities

The dynamic design of the EndoSync cordless handpiece offers a unique combination of Safety and Performance all in one handpiece. This high performance endodontic motor is the lightest cordless handpiece in its class with numerous safety features, including Optimized Torque Reverse (OTR) technology, torque slowdown, and the ability to connect to the EndoSync A.I. Apex Locator. The EndoSync offers the safety you deserve with the efficiency you require.



**Order Number: 5025411U0**

Set Includes Motor, Head, Charging Base

Weight: 100 grams

6 Memory Settings

Speed Range: 50-1,000 rpm

Rechargeable Lithium Ion Batteries

1 Year Warranty

# ENDOSYNC™ A.I.

**Order Number: 5025412U0**

Weight: 110 grams

Size (mm): 60 (w) × 103 (d) × 57 (h)

Battery: DC 1.5V AAA

3 Memory Settings

1 Year Warranty

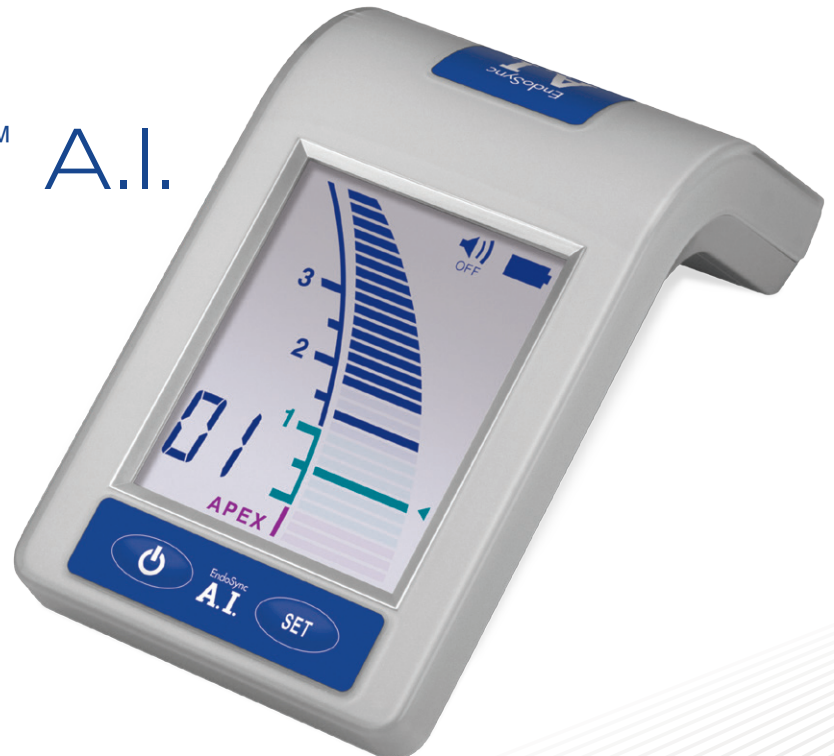

\*Transmission cable required to connect to EndoSync A.I.

# ENDODONTIC SERIES

## *A New Generation of Endodontic Technology...*

The endodontic handpieces and small equipment from Brasseler USA usher in a new generation of technology for successful root canal treatments. From the advanced power heat source of the EndoPro 270 to the flexibility of the cordless EndoSequence 2, Brasseler USA delivers the superior benefits required in your practice.





# ENDOSEQUENCE® 2

## Order Number: 5021327U0

Set Includes Motor, 10:1 head, Charging Base  
5 Programmable Settings  
Auto Reverse  
Torque Control  
Speed Range: 200-1,000 rpm  
AAA Rechargeable Batteries  
1 Year Warranty



# ENDOPRO 270™

## Order Number: 5019927U0

Set Includes Handpiece, Charging Base, and SML  
Heated Plugger  
Weight: 63 g  
6 Temperature Settings up to 270°C  
1 Year Warranty



# ENDODRIVE PLUS™

## Order Number: 5021328U0

Set Includes Motor, 20:1 head, Control Unit and AC Adapter  
9 Programmable Settings  
Auto Reverse  
Torque Control  
Speed Range: 100-650 rpm  
1 Year Warranty



# FORZA™ V3

*Elegant and Intuitive...*

At only 33 grams, the slim, ergonomic design of the Forza V3 handpiece provides excellent access while reducing hand fatigue. Stunning LED illumination from dual fiber optics delivers clearer vision and maximum visibility. Equally important is the Piezo Accelerator mode that instinctively provides additional power at the moment you need it most. The compact, space saving unit complements the simple-to-operate interface and can be easily installed in any dental operatory. With a wide range of piezo ultrasonic tips available, the Forza V3 is ideal for a variety of clinical procedures including general scaling, perio and endo.



## Forza V3 LED Complete Set

**Order Number: 5023152U0**

Set includes Control Unit, Handpiece, Control Unit Holder, Water Filter and Connector Set, Foot Control, Tip Wrench, AC Adapter, Three Scaling Tips (G1, G9, G11)

LED Fiber Optic

General, Perio & Endo Modes

Easy Power & Water Adjustment

Piezo Accelerator Mode



## Forza V3 Non-Optic Complete Set

**Order Number: 5023153U0**

Set includes Control Unit, Handpiece, Control Unit Holder, Water Filter and Connector Set, Foot Control, Tip Wrench, AC Adapter, Three Scaling Tips (G1, G9, G11)

Non-Fiber Optic

General, Perio & Endo Modes

Easy Power & Water Adjustment

Piezo Accelerator Mode

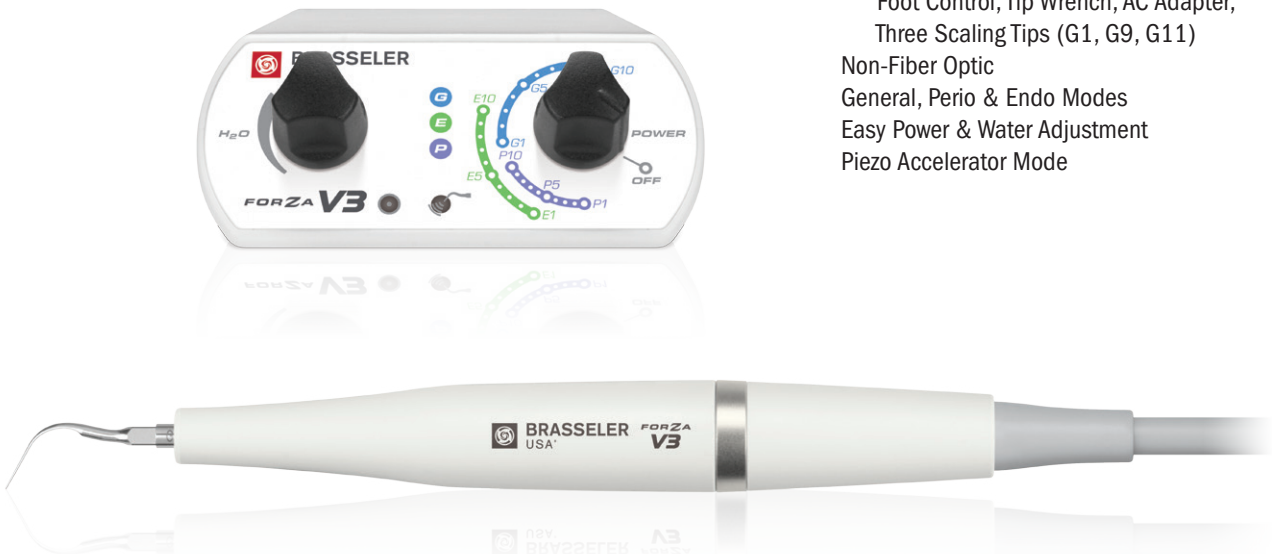



# HYGIENEPRO™

*Enhance Your Performance...and Your Patient's Comfort.*

The Brasseler USA HygienePro Handpieces are triumphs in ergonomic design for today's busy dental hygiene professional. From the compact, lightweight design of the HygienePro Air motor to the versatile, battery powered HygienePro Cordless, Brasseler USA offers the handpiece that fits your hygiene needs.

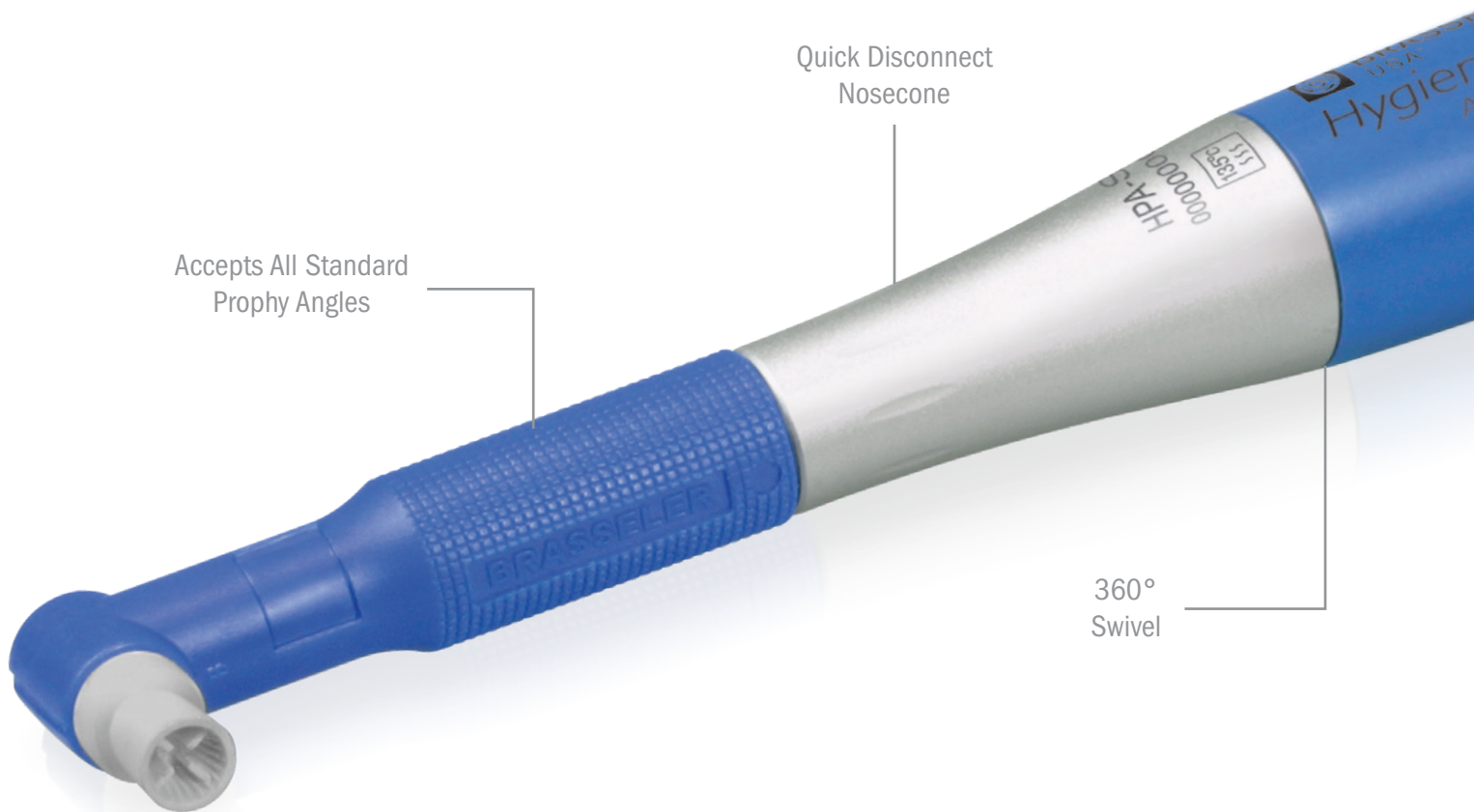

# HYGIENEPRO™ AIR

**Order Number: 5021318U0**

Maximum Motor Speed: 2,600 rpm

Weight: 2.5 oz.

Length: 4.0 inches

Connects Directly to 4 Hole Tubing

1 Year Warranty



# HYGIENEPRO™ CORDLESS

**Order Number: 5021324U0**

Variable Speed Range: 500-2,500 rpm

9 Speed Settings

Battery Life Indicator

1 Year Warranty



# BSPMICRO™

## Small Bone Power System

*Power. Precision. Performance.*

The BSPMicro Small Bone Power System from Brasseler USA offers a wide range of drills for a variety of oral surgery procedures. Fully compatible with ConMed® Linvatec® pneumatic system, the BSPMicro is engineered and tested to Brasseler standards of high quality and will be an outstanding addition to your practice.

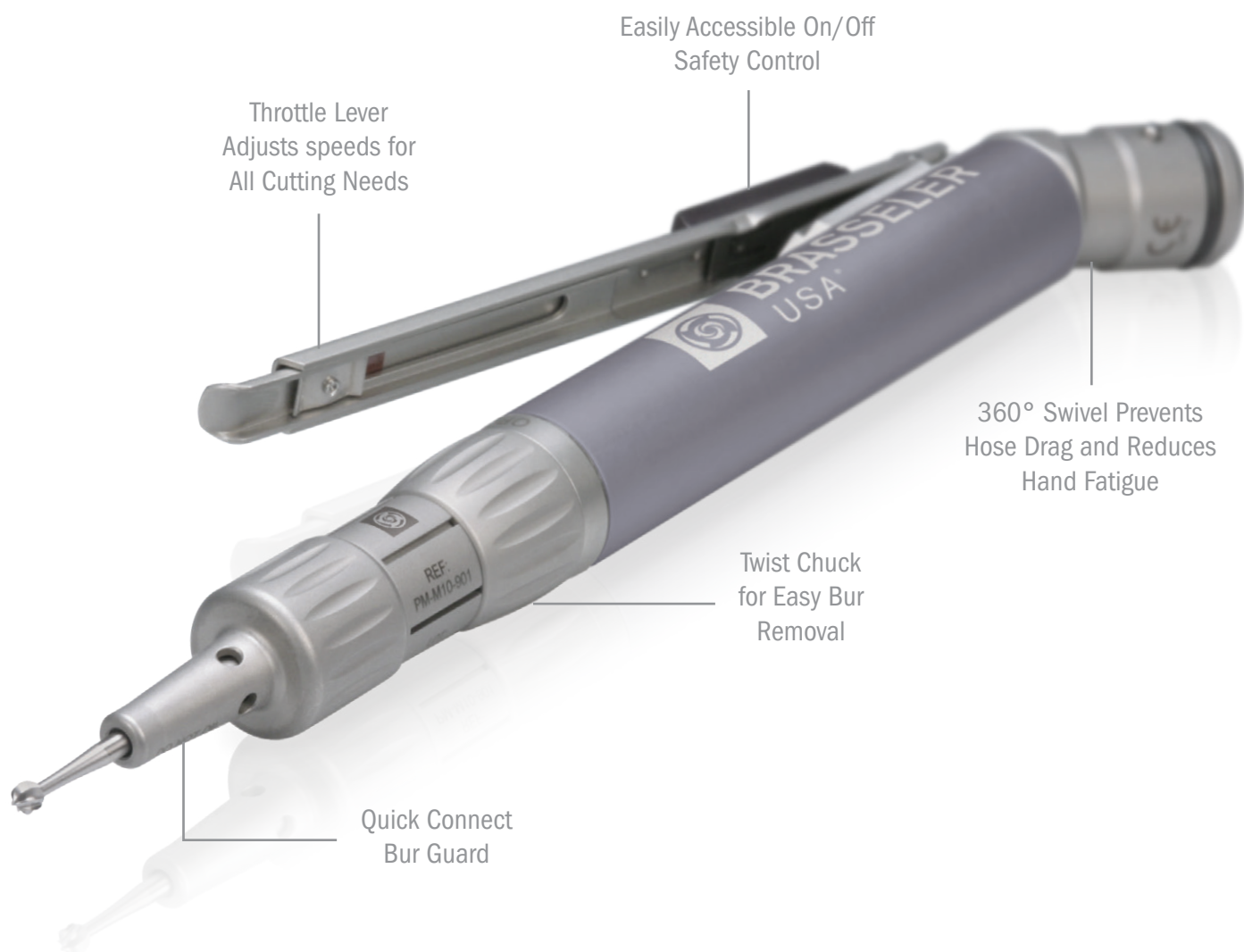



The Brasseler USA Drill is designed for drilling, cutting and sculpting of small bone and enamel and is ideal for third molar extractions. Used with 2.35 mm shank burs, the drill accepts a wide range of twist drills and diamond, carbide and stainless steel burs in medium and long lengths.

High Speed Drill



Medium Speed Drill

**PM-M09-200 High Speed Drill**

**Order Number: 5010867M1**

Speed Range: 0-95,000 rpm  
 Torque: 1.75 in-oz (1.24 N-cm)  
 Operating Pressure: 90-110 psi (6.2 - 7.6 kg/cm<sup>2</sup>)  
 Weight: 0.45 lb (0.2 kg)

*Compared to ConMed® Linvatec® # 5058-001*

**PM-M10-200 Medium Speed Drill**

**Order Number: 5010868M0**

Speed Range: 0-25,000 rpm  
 Torque: 6.0 in-oz (4.24 N-cm)  
 Operating Pressure: 90-110 psi (6.2 - 7.6 kg/cm<sup>2</sup>)  
 Weight: 0.40 lb (0.18 kg)

*Compared to ConMed® Linvatec® # 5053-009*



**PM-M10-901 Medium Bur Guard**

**Order Number: 5010873M0**

Recommended Bur Length: 44.5-69mm

*Compared to ConMed® Linvatec® # 1375-012*



**PM-M10-902 Long Bur Guard**

**Order Number: 5010874M0**

Recommended Bur Length: 70-94mm

*Compared to ConMed® Linvatec® # 1375-011*



**PM-M12-200 Sagittal Saw**

**Order Number: 5010870M0**

Speed Range: 0-18,000 cpm  
 Oscillation Arc: 4°  
 Weight: 0.42 lb (0.19 kg)

*Compared to ConMed® Linvatec® # 5053-011*



**PM-M13-200 Oscillating Saw**

**Order Number: 5010871M0**

Speed Range: 0-22,000 cpm  
 Oscillation Arc: 7°  
 Weight: 0.49 lb (0.22 kg)

*Compared to ConMed® Linvatec® # 5053-012*

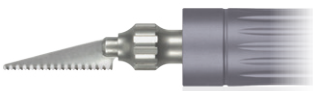

**PM-M14-200 Reciprocating Saw**

**Order Number: 5010869M0**

Speed Range: 0-18,000 cpm  
 Blade Travel: .078 in (2.0 mm)  
 Weight: 0.43 lb (0.2 kg)

*Compared to ConMed® Linvatec® # 5053-010*



**PM-M11-200 Wiredriver**

**Order Number: 5014081M0**

Speed Range: 0-2,100 rpm  
 Torque: 45 in-oz (31.8 N-cm)  
 Wire/Pin Diameter Range: 0.028-0.078 in (0.7-2.0 mm)  
 Weight: 1.43 lb (0.65 kg)

*Compared to ConMed® Linvatec® # 5053-013*

# FORZA™ L50K

*Uncompromising Power...*

The Forza L50K Lab Micromotor delivers uncompromising power throughout its advanced design. The cutting edge technology incorporated in the Forza L50K offers a massive 8.7 Ncm of torque and a speed range of 1,000-50,000 rpms. The lightweight, ergonomic handpiece weighs only 219 grams ensuring precise control and reduced hand fatigue.





**Forza L50K MicroMotor**

**Order Number: 5021337U0**

Motor Speed Range: 1,000-50,000 rpm

Maximum Torque of 8.7 Ncm

Brushless

Weight: 219 grams

1 Year Warranty



**Forza L50K Complete System**

**Order Number: 5021334U0**

System includes Motor, Cord, Control Unit,  
Foot Control and AC Adapter

Digital Speed Display

Easy-to-Operate Display Panel

Foot Pedal or Hand Control Option

Auto Cruise Function

1 Year Warranty





DIAMONDS

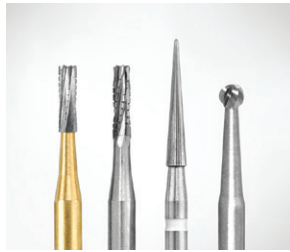

CARBIDES



POLISHERS



PROCEDURE SYSTEMS



BIOCERAMICS



Since 1976, our absolute focus has been to develop products and provide services that support the practice of core operatory procedures. Today, Brasseler USA® is the premier dental instrumentation company in North America offering the most extensive selection of dental and surgical instrumentation under one brand.



HANDPIECES



ENDODONTICS



SMALL EQUIPMENT



HYGIENE



HAND INSTRUMENTS



ORAL SURGERY



LABORATORY INSTRUMENTS



Visit our website at [BrasselerUSA.com](http://BrasselerUSA.com)

To order call 800.841.4522 or fax 888.610.1937. In Canada call 800.363.3838

