

# BRASSELER MINI

## THE SMALLEST BIG IDEA IN DENTISTRY

Small in size but big in performance, the Brasseler Mini high speed handpiece offers a super miniature head size that provides maximum access and visibility. A revolution in handpiece design, the Brasseler Mini is a necessity for your limited access cases.

- ▶ *Lightweight*
- ▶ *Fiber Optic Light*
- ▶ *Easy to Replace Turbine*
- ▶ *Ceramic Ball Bearings*
- ▶ *Clean Head System*
- ▶ *Single Port Water Spray*
- ▶ *Quick Disconnect Swivel*
- ▶ *Push Button*

Order No. 5021970U0

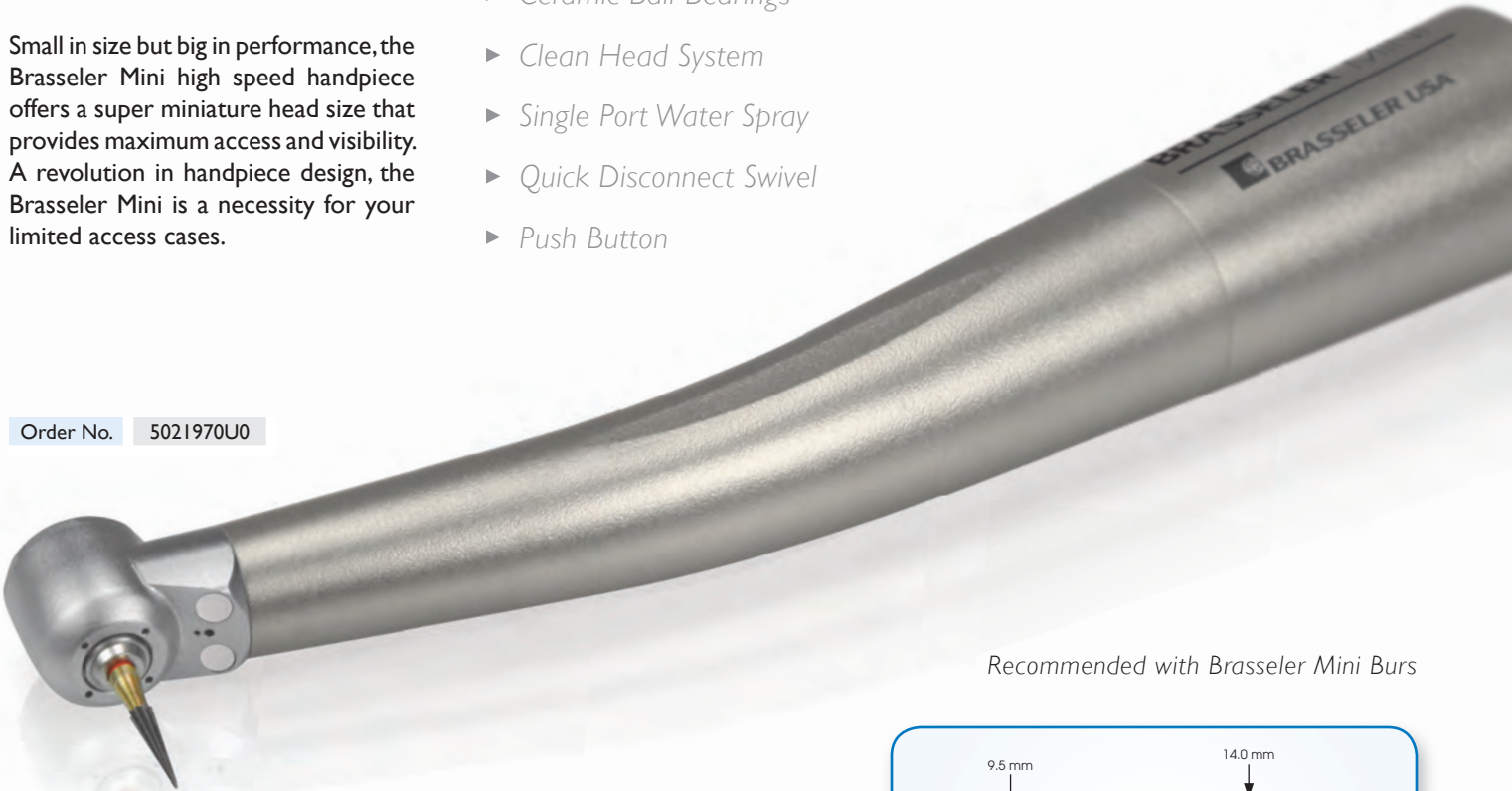

Recommended with Brasseler Mini Burs

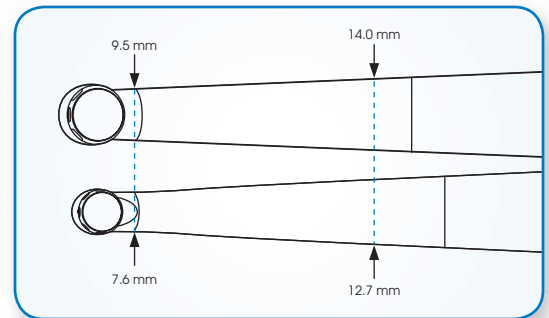
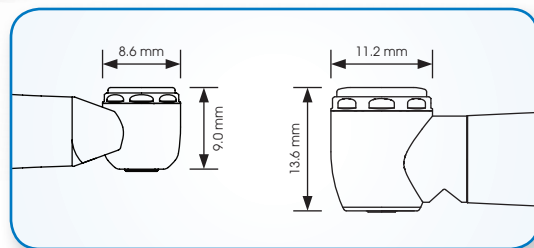

By Your Side  
in Dentistry



**BRASSELER USA**  
DENTAL INSTRUMENTATION



To order call 800.841.4522 or fax 888.610.1937.  
In Canada call 800.363.3838 or fax 866.330.4454.  
Visit our website at [BrasselerUSA.com](http://BrasselerUSA.com)



# BRASSLER MINI BURS

The small bur with big benefits, the Brasseler Mini bur is available in a variety of shapes and sizes. Shorter than conventional friction grip burs, Brasseler Mini burs deliver unprecedented access when combined with the Brasseler Mini high speed handpiece.





K0253  
Mini Combo Kit

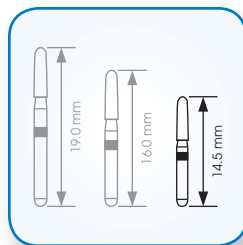







Order No. 5021978U0











## OPERATIVE CARBIDES

		
<b>US Number</b>	<b>330M</b>	<b>557M</b>
Figure Number	H7	H31
Head Size (1/10 mm)	008	010
Cutting Length (mm)	1.6	4.2
Description	Pear	Flat-End Fissure
32 FG - Mini	330M	557M



## TRIMMING & FINISHING CARBIDES

								
<b>US Number</b>	<b>ET3.5M</b>	<b>ET5M</b>	<b>ET7M</b>	<b>ET8.5M</b>	<b>OS3M</b>	<b>OS2M</b>	<b>7404M</b>	<b>OSIM / 7408M</b>
Figure Number	H132VG	H133VG	H134VG	H135VG	H247VG	H247VG	H379	H379
Head Size (1/10 mm)	009	012	014	014	007	009	014	023
Cutting Length (mm)	3.5	5.0	7.0	8.5	3.2	3.2	3.1	4.2
Description	ET® Series				ET® Series - Bullet		ET® Series - Egg	
 Fine (8-12 Blade)	ET3.5M	ET5M	ET7M	ET8.5M	OS3M	OS2M	7404M	7408M

## DIAMONDS

					
<b>Figure Number</b>	<b>379M</b>	<b>30011M</b>	<b>855M</b>	<b>845KRM</b>	<b>846KRM</b>
Head Size (1/10 mm)	023	012	016	018	016
Cutting Length (mm)	-	6.5	6.0	4.0	6.0
Description	Egg	Flame	Round-End Taper	Modified Flat-End Taper	
 Super-Coarse	5379M	35011M-052	5855M	-	5846KRM
 Medium	379M	30011M-052	855M	845KRM	846KRM
 Fine	8379M	38011M-052	8855M	-	8846KRM

## DEPTH CUTTERS

		
<b>US Number</b>	<b>RW 2</b>	<b>RW 2.5</b>
Figure Number	845KRA	845KRB
Head Size (1/10 mm)	018	018
Cutting Length (mm)	2.0	2.5
Depth Cut (mm)	2.0	2.5
Description	Depth Cutters	
 Medium	RW 2	RW 2.5

By Your Side  
in Dentistry



**BRASSLER USA**  
DENTAL INSTRUMENTATION



To order call 800.841.4522 or fax 888.610.1937.  
In Canada call 800.363.3838 or fax 866.330.4454.  
Visit our website at BrasselerUSA.com

